

» PL20BNH

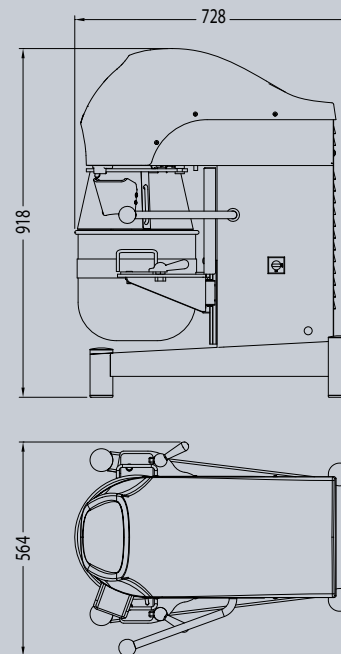

PL20BNVH



- Capacità vasca 20 litri
- Variatore elettronico di velocità con inverter
- Pannello touch commands IP54
- Versione da banco e da pavimento
- Sollevamento vasca manuale
- Protezione antinfortunistica fissa/girevole in plastica "F"
- Struttura in acciaio verniciato o in acciaio inox su richiesta

- Bowl capacity 20 liters
- Electronic variable speed by inverter
- Touch commands panel IP54
- Bench and floor version
- Manual bowl lift
- Fixed rotating plastic safety guard "F"
- Structure in painted steel or in stainless steel on request

- Capacité cuve 20 litres
- Variateur électronique de vitesse par inverter
- Panneau de commandes touch IP54
- Version à poser sur table ou à poser au sol
- Levage de la cuve manuel
- Protection de sécurité fixe tournant en plastique "F"
- Structure en acier verni ou acier inox sur demande

- Capacidad cuba 20 litros
- Variador electrónico de velocidad con inverter
- Panel de comando touch IP54
- Versión de sobre mesa y suelo
- Elevación manual del perol
- Protección de seguridad fija giratoria de plástico "F"
- Estructura de acero pintado o acero inox bajo demanda

- Объем дежи 20 л
- Электронный вариатор скорости
- Панель управления с сенсорным экраном IP54
- Настольные и напольные модели миксера
- Миксер с подъемом дежи вручную
- Корпус из окрашенной или нержавеющей стали (по запросу)

Accessori standard - Standard accessories



Vasca
Bowl

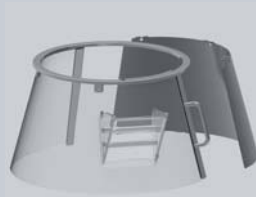

Protezione fissa/girevole in plastica "F"
Fixed rotating plastic safety guard "F"



Frusta fili fini
Fine wire whisk



Spatola in alluminio
Aluminium beater



Gancio in alluminio
Aluminium hook

Codice macchina Machine code	Capacità vasca Bowl capacity	Peso macchina Machine weight	Potenza Power	Velocità Speed	Voltaggio standard Standard voltage	Riduzioni Reduction
	l	kg	kW	rpm	V / PH / Hz	l
PL20BNVHF	20	90	1,1	min. 47 (120) max. 164 (418)	230 / 1 / 50 - 60	10

